

The *Choices* brand

Windows, Doors, Conservatories

The *Choices* brand

Alu-Clad

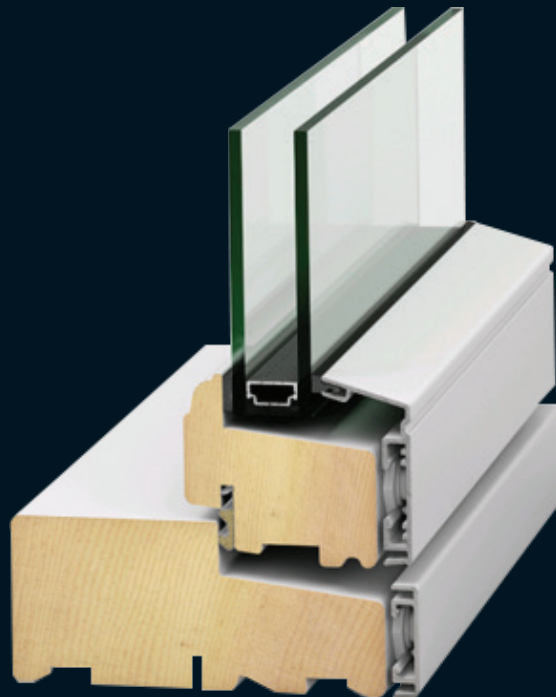

The best of “Two Worlds”

Timber and Aluminium

'Choices' Alu-Clad Timber

Aluminium Clad Timber Windows and Doors

A highly durable, low-maintenance, versatile solution for domestic and commercial applications.

Alu Clad timber windows and doors are manufactured from timber with an external aluminium cladding combining high levels of insulation and a low maintenance exterior finish.



Flush Casement / Fully Reversible Windows

Outward opening flush casement windows with clean, straight edged timber frames and external aluminium cladding for a low maintenance solution. As an outward opening casement window, the functionality also allows for fully reversible for easy maintenance and cleaning.

The internal timber is, as standard, square edged (Softline) however it is also available with a slightly moulded, decorative finish (Classic).

Specification

- ✓ Engineered (laminated) timber profiles
- ✓ Pine timber with external aluminium cladding
- ✓ Factory applied paint / clear on white tone lacquer
- ✓ Polyester Powder Coated (PPC) aluminium
- ✓ Casement and reversible hinges
- ✓ All multi-point locking
- ✓ Modern square profile - Softline
- ✓ Traditional moulded profile - Classic
- ✓ Factory fitted double or triple glazing
- ✓ Double glazed with overall U-value of approx 1.34W/m²K
- ✓ Triple glazed with overall U-value of approx 0.92W/m²K
- ✓ Externally beaded, drained and ventilated
- ✓ PAS24 option available



Exceptionally insulated windows and doors

With aluminium clad timber, the added layer of protection and finish allows windows and doors to withstand even the most severe conditions.

CWG Choices offer a range of products including Flush Casement, Fully Reversible, Tilt and Turn and a selection of Alu-Clad doors; each designed to fit specific requirements.

All of our Alu-Clad products achieve outstanding thermal performance, with a number of triple-glazed products reaching U-values below 1W/m²k.

Low maintenance

The external aluminium cladding minimises the amount of maintenance and maximises the choice of colours, making Alu-Clad Timber the ultimate hassle-free solution for a wide range of applications!



'Choices' Alu-Clad Tilt and Turn

High performance inward opening, tilt & turn windows with an external aluminium cladding which provides a strong, durable external surface requiring minimal maintenance. This reduces future costs and improves the life expectancy of the product.

Specification

- ✓ Timber only option available
- ✓ Engineered (laminated) timber profiles
- ✓ Pine or Oak
- ✓ Factory applied paint/clear lacquer/white tone lacquer options internally
- ✓ Tilt & turn, tilt only or turn only - all inward opening
- ✓ Circumferential fittings with tilt ventilation
- ✓ Factory fitted 24mm double glazing or 40mm triple glazing
- ✓ Internally beaded
- ✓ Overall U-value of (approx.) 1.2W/m²K - double glazed or 0.9W/m²K - triple glazed
- ✓ Shaped opening windows possible
- ✓ Durable external aluminium cladding
- ✓ PAS24 option available

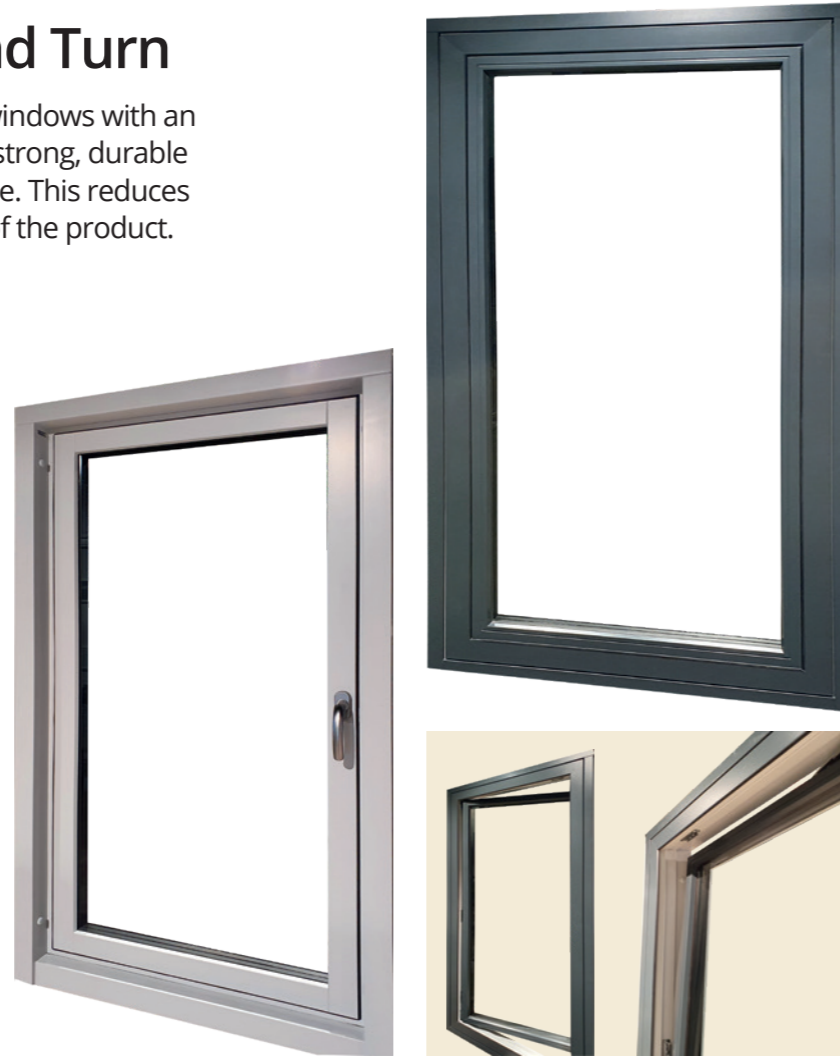

Patio Sliding Doors

Alu-Clad Doors

Our Alu-Clad Door range is a high performance system, with a wide range of optional features tailored to your needs, including Single, Double, Stable, Sliding and Bi-Folding Door types.

Strong and durable aluminum cladding on the exterior combined with the warmth and the beauty of wood on the interior, make our doors both striking and virtually maintenance free.

With such a vast range of different solutions, each offering their own unique design features, we can offer a tailored solution perfect for your project.



Multifold Doors



Single Doors



Double Doors

Standard RAL Colours - External Only (All RALs available)



Stains - Internal Only

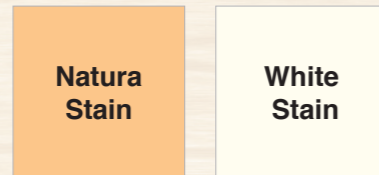

Due to the printing process, colour variation may occur between printed visuals and the end product

Window Hardware



Flush Casement Handles
Satin or White

Tilt and Turn Handles
Satin or White

Door Hardware

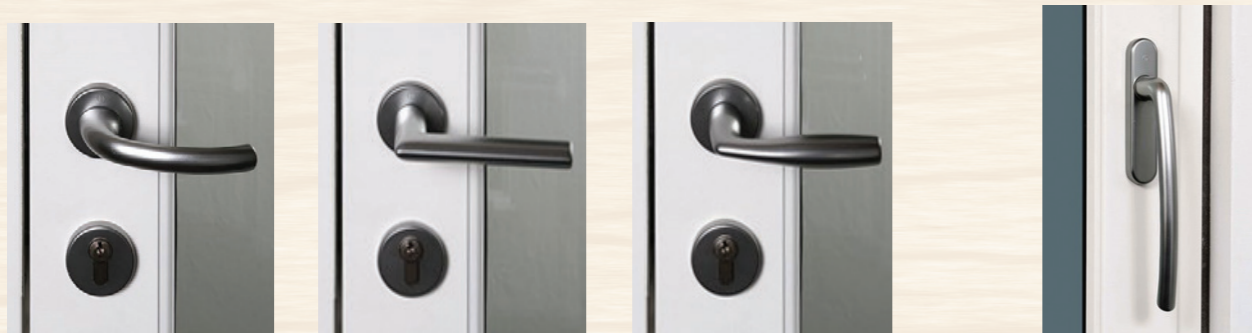

Door Handles
Satin or White

Sliding Door Handles
Satin or White

STANDARD SPECIFICATIONS

Configurations and Sizes

Products are available in numerous configurations which can be combined to provide the best solution.

Below are the recommended min and max sash sizes in mm for each configuration:-

Side Hung (Butt hinged outward opening)

Min 328W x 378H
Max 868W x 1668H

Side Swing 90° (Outward opening windows)

Min 398W x 468H
Max 868W x 1668H

Top Guided (Outward opening windows)

Min 408W x 328H
Max 1568W x 1568H

Top Hung Reversible (Outward opening windows)

Min 408W x 798H
Max 1568W x 1568H

Fixed Window

Min 218W x 218H
Max 2468W x 2468H

Fixed Sash

Min 328W x 518H
Max 2468W x 2468H

Entrance Doors (Inward and outward opening)

Min 408W x 1268H
Max 1118W x 2293H

French Doors (Inward and outward opening)

Min 788W x 1768H
Max 2178W x 2293H

Sliding Patio Doors

Min 1398W x 1378H
Max 4198W x 2400H

Construction

All timber used in the manufacture of Alu-Clad is harvested from well managed forests. We are proud to only use softwood that is FSC Certified Timber.

Working with a natural material such as wood means taking our environmental responsibilities very seriously. We do this by conserving resources and selecting wood at the highest available quality. We then scan the wood to identify any imperfections by cutting out and finger jointing leaving you with a flawless finish.

Standard frame size is 125mm.

The timber corner joints are double tenoned; the integrated aluminium frame is mechanically connected and corner joints are mitred and crimped.

Glazing - available double or triple glazed

24mm (4/16/4) • 40mm (4/14/4/14/4)

The bottom rebate in all openings has a fully drained and vented system to allow water to drain and air to circulate. The "Low E", double glazed, sealed units are fixed into position with polyester powder coated aluminium cladding/ glazing bead system.

Glazing Bars

Glazing bars, transoms and mullions can be added into the frame to form different glazed or sash configurations. Combined with a variety of Add-On Bars, you can create various designs within the glazing areas. 25/42/60mm Plant-On-Bars, 60mm Solid Bars.

Ironmongery

We use a range of ironmongery obtained from the best manufacturers, making sure that they comply with all the latest standards.

All hinges and espagnolette system are manufactured from high grade materials that provide high mechanical performance

Restrictors

Reversible windows have a restrictor built into the hinge, (child safety restriction at 100mm) and have a fully reversible restriction for cleaning (no brake option). All other configurations have restrictors as an option.

Factory Finish

'Choices' windows and doors are supplied fully finished using water based paints and stains and are preserved with an environmentally friendly biodegradable protection treatment against rot and mould.

The external aluminium cladding has a polyester powder coating (minimum 60 micron thickness) in standard RAL colours. Standard gloss in 30%, with optional 77% gloss available upon request.

Ventilators

Ventilators are available on request.



For PAS 24 size limitations will apply

Alu-Clad Window - Sectional Details

OUTWARD SIDE HUNG WINDOW

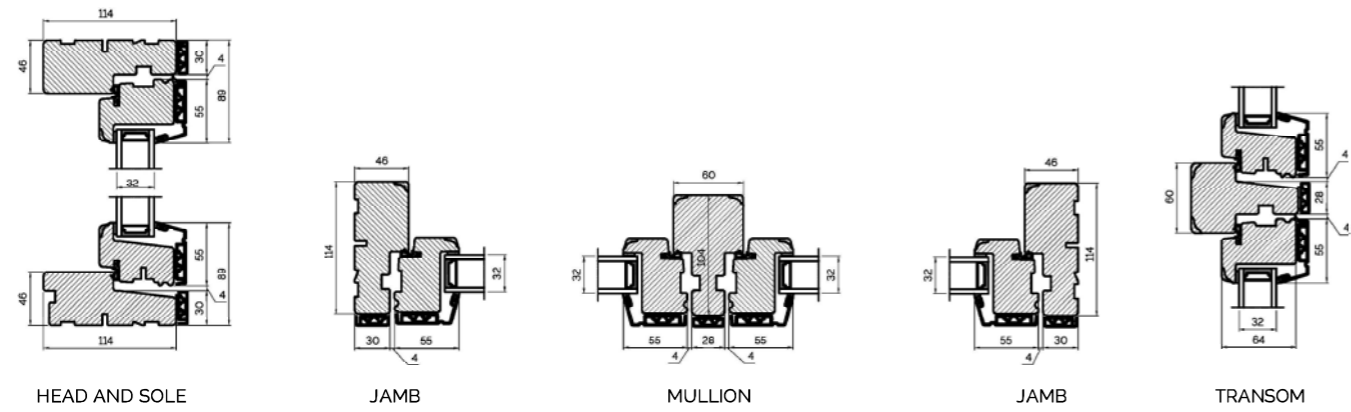

FIXED FRAME WINDOW

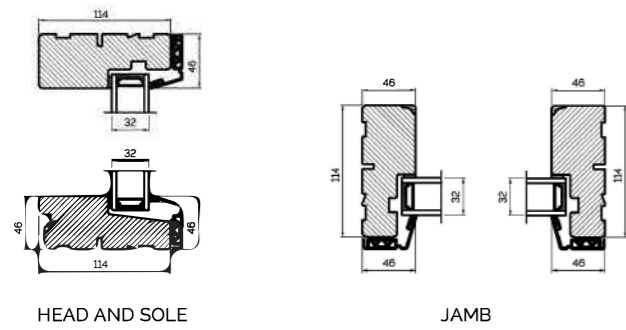

TILT & TURN WINDOW

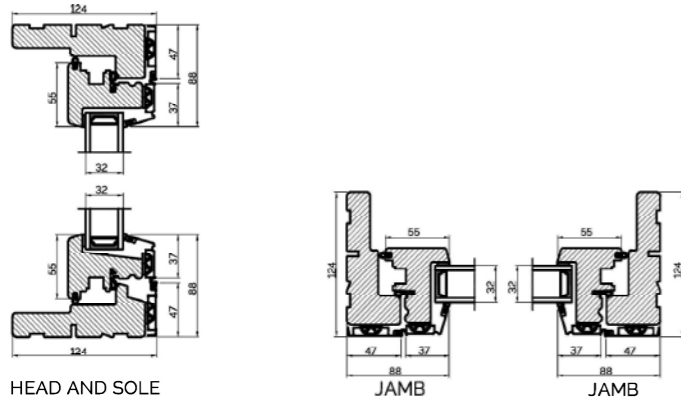

CORNER POSTS

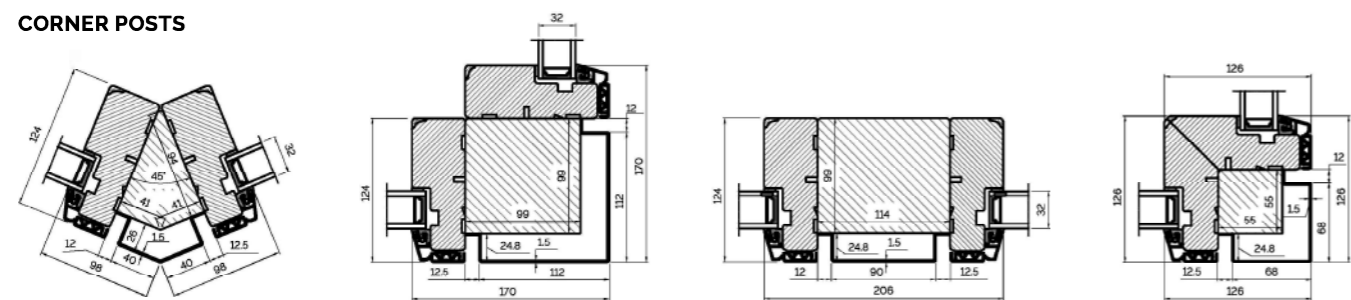

BONDED BARS

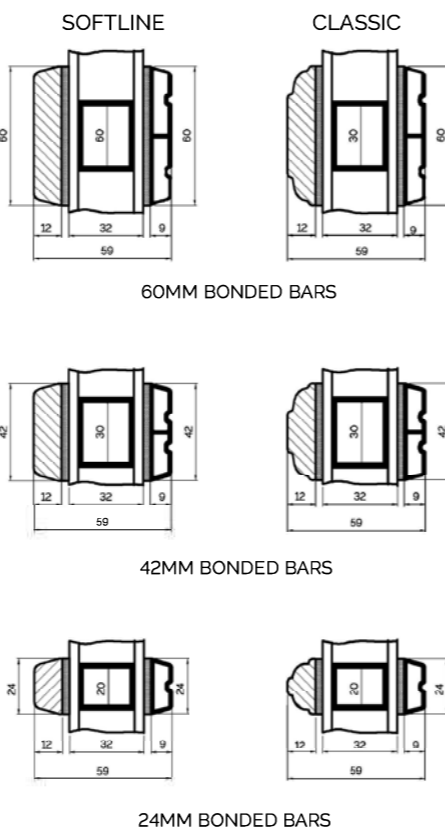

Alu-Clad Doors - Sectional Details

DOUBLE DOOR OPEN OUT

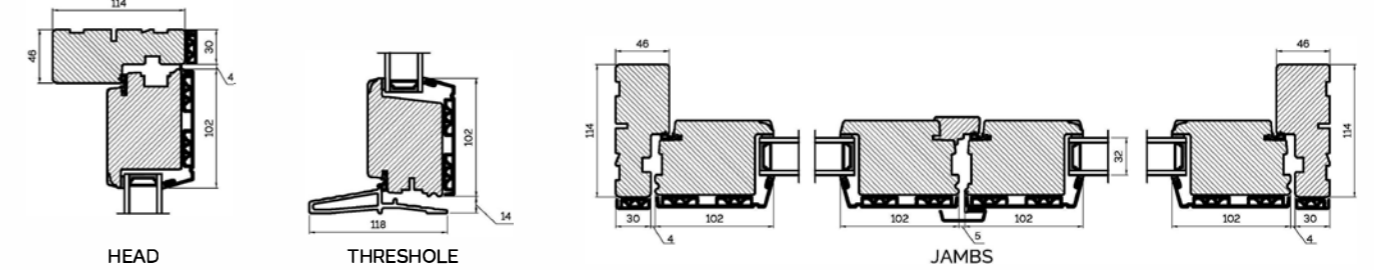

DOUBLE DOOR OPEN IN

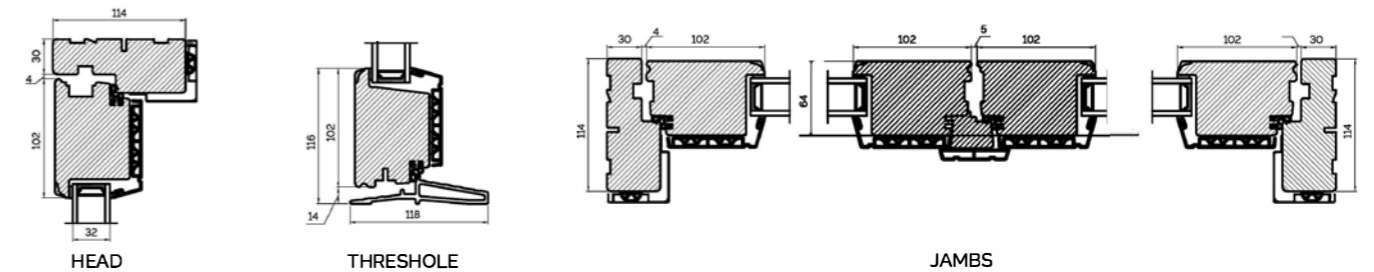

SINGLE DOOR OPEN IN

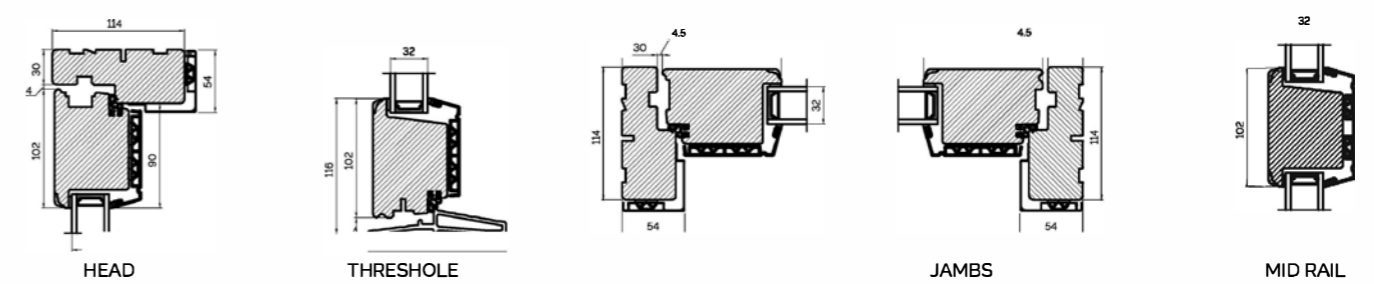

SLIDING DOOR

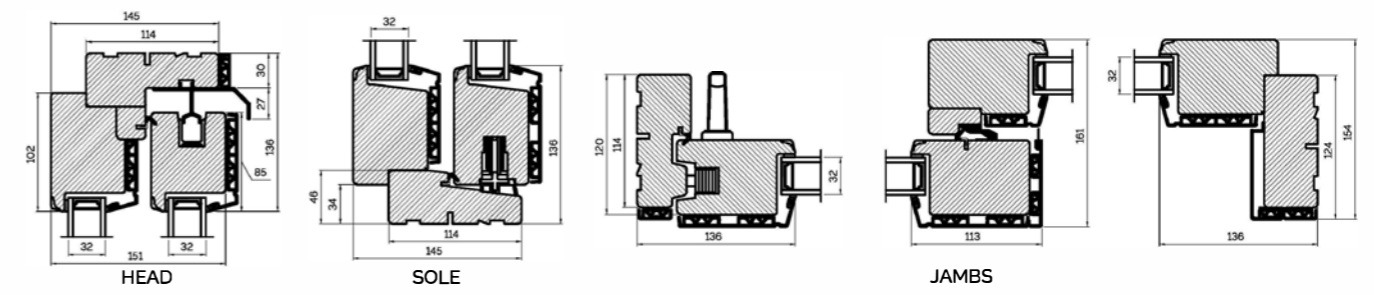

BI-FOLDING DOOR

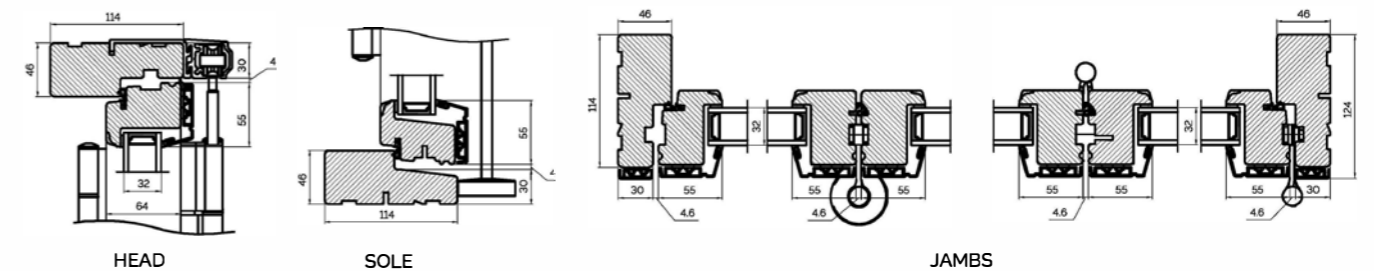

Windows Overview



FIXED FRAME WINDOWS



SIDE HUNG WINDOWS



SIDE GUIDED WINDOWS

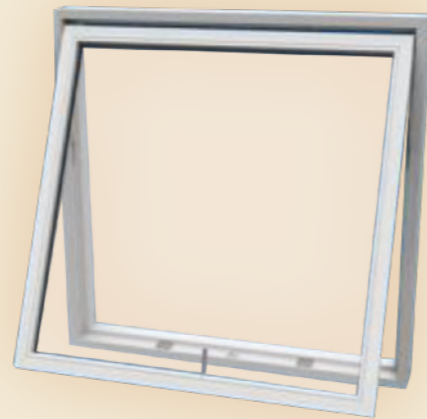

TOP GUIDED WINDOWS

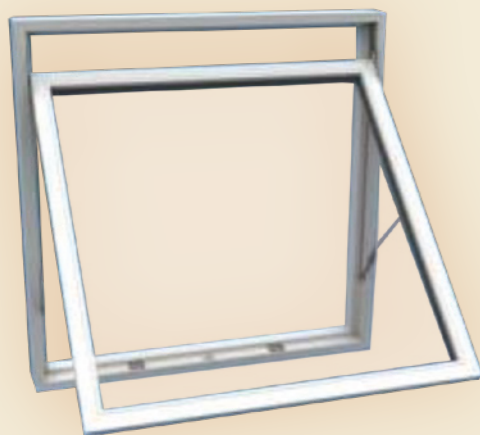

FULLY REVERSIBLE WINDOWS



TILT & TURN WINDOWS

Doors Overview



EXTERIOR DOORS

Choose from 74 different exterior doors that are available in many styles from classic, modern, country and romantic options.



BI-FOLDING DOORS

Combining outdoor and indoor living, bi-folding doors creating vast openings, integrating living spaces with the garden or patio in an instant.

Available up to 7meters wide.



SLIDING DOORS

Sliding doors provide unbroken views of the garden with their wide leaves and panes of glass. Configurations can be made to have a single sliding door or two opposite (double) sliding doors.

The *Choices* brand

Alu-Clad



The best of Two Worlds

The *Choices* brand

Windows, Doors, Conservatories

Why not consider the other collections available from Choices

Windows, Doors, Conservatories & Orangeries manufactured from state of the art PVCU and Aluminium for Domestic and Commercial properties.