

Aluminium In-line Sliding and Lift & Slide Doors

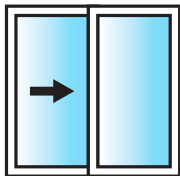

In-line Sliding Doors



2 Pane

*Minimum width 1400mm
(at 2100mm high)
Maximum width 4500mm
Maximum Height 2300mm*

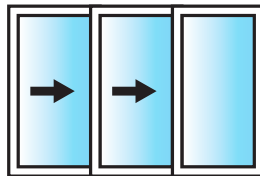

3 Pane (Triple Track)

*Minimum width 2700mm
Maximum width 6000mm
Maximum Height 2300mm*

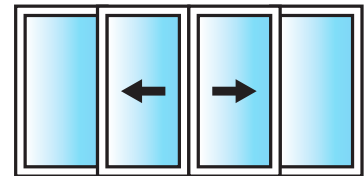

4 Pane

*Minimum width 3600mm
Maximum width 6000mm
Maximum Height 2300mm*

Lift and Slide Doors (Duo Rail)

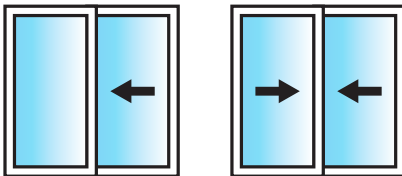

2 Pane

*Minimum width 1400mm
(at 2100mm high)
Maximum width 4500mm
Maximum Height 2400mm*

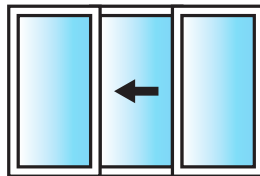

3 pane

*Minimum width 2700mm
Maximum width 6000mm
Maximum Height 2400mm*

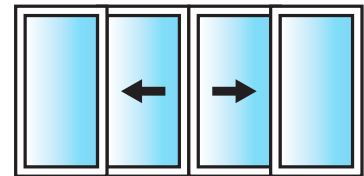

4 pane

*Minimum width 3600mm
Maximum width 6000mm
Maximum Height 2400mm*

Colour Range
for fast delivery

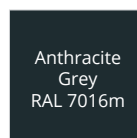

*Charge as
standard RAL
dual colour*

Configurations Door sash width cannot be less than 3x smaller than the height of the door

Aluminium In-line Sliding and Lift & Slide Doors

Combining high performance with stunning design, our 'In-line Sliding' and 'Lift & Slide' doors provide a versatile solution for any architectural project.

'Choices' Optio BSC94 In-line Sliding and Lift and Slide options

Standard Design Features

- ✓ 3 Chambered doors
- ✓ 28mm sealed units
- ✓ 4 hook locks (Slider only)
- ✓ Black or white handles
- ✓ Black buffer stops
- ✓ 'U' Value 1.7 Wm²K with double glazing
- ✓ Dual rail



Optional 45mm Slim Interlock - Sliding and Lift and Slide

Standard Interlock

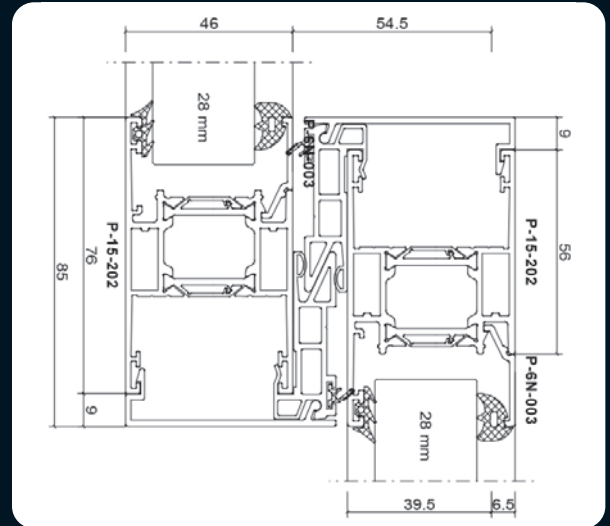

As overall sizes increase, additional external reinforcing will be required

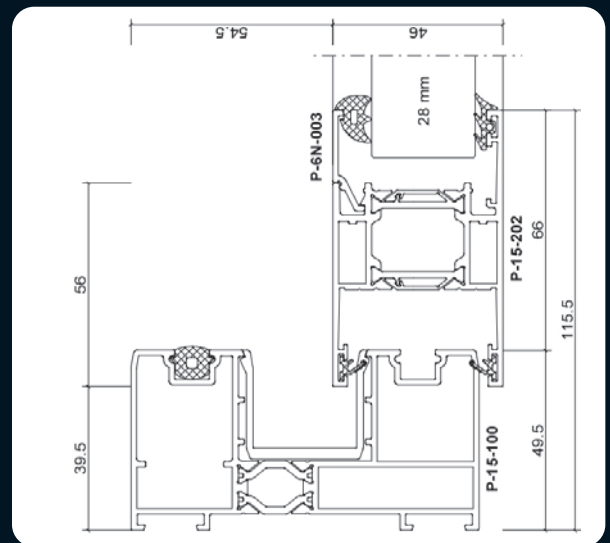

Threshold and Sash

Upgrades/Options

- ✓ A range of RAL single or dual colour
- ✓ PAS 24 / Doc Q (2 pane In-line slider only)
- ✓ Brushed chrome handles
- ✓ Triple track slider - no cill available - 155mm frame - 6 week lead time
- ✓ 45mm slim interlock

Why not consider the other collections available from *The Choices* brand

Windows, Doors, Conservatories & Orangeries manufactured from state of the art PVCU and Aluminium for Domestic and Commercial properties.